



# Tarasola®



## Tarasola Carport Tarasola Fix

PL EN

Tarasola.com

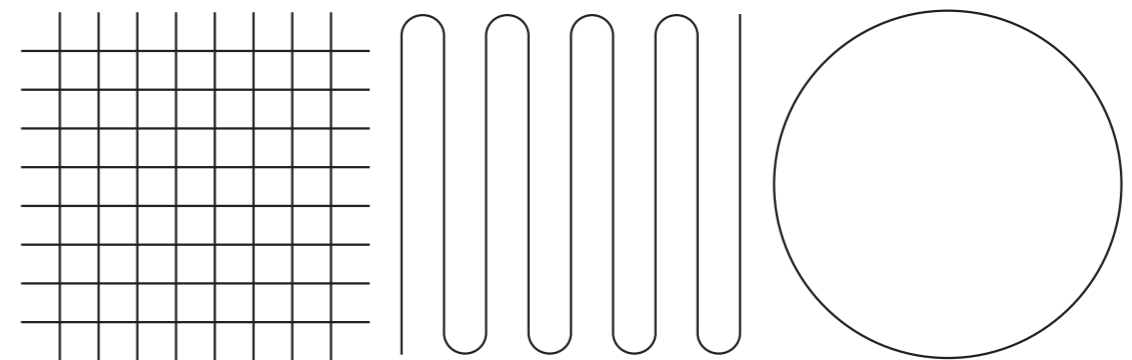
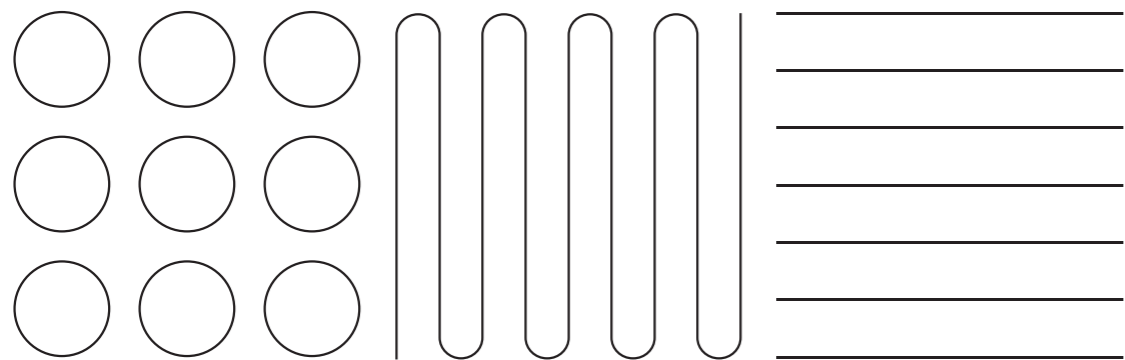

# Spis treści

## Table of contents

- 02 **Opis produktu** | Product description
- 04 **Galeria zdjęć** | Photo gallery
- 20 **Cechy kluczowe** | Key features
- 21 **Przekroje** | Cross-sections
- 22 **Modele i maksymalne wymiary** | Models and maximum dimensions
- 25 **Ładowarka do samochodu JUICEBOX PRO**  
| Car Charging Station JUICEBOX PRO
- 26 **Panele fotowoltaiczne** | Photovoltaic panels
- 28 **Zabudowa boczna** | Side development
- 29 **Akcesoria** | Accessories
- 30 **Paleta kolorów** | Colour range
- 32 **Certyfikaty** | Certificates
- 32 **Nagrody** | Awards

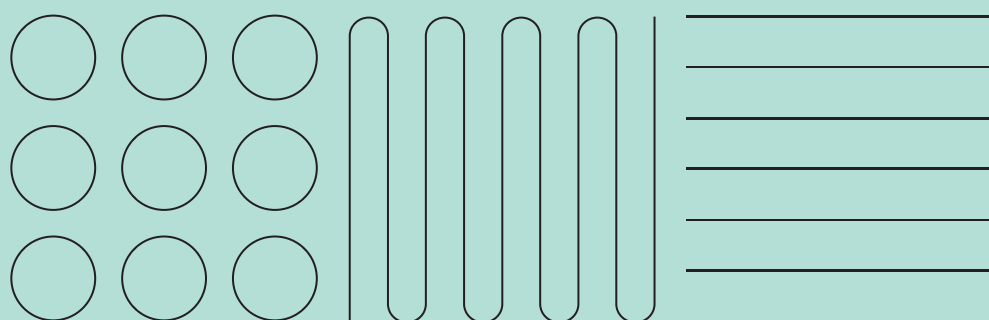



# Opis produktu

## Product description

PL

**Tarasola Carport** to nowoczesna wiata garażowa. Jest to solidne, stałe zadaszenie, które chroni auto przed słońcem, deszczem, wiatrem i śniegiem. Minimalistyczna forma, estetyczne wykończenie, bez widocznych elementów mocowania oraz wybór kolorów pozwala wpasować Carport w każde otoczenie.

### Tarasola Carport = Tarasola Fix

Konstrukcja Carport może z powodzeniem stanowić standardowe zadaszenie tarasu. W tej opcji polecamy dołożenie dachu dolnego w postaci estetycznej tkaniny oraz wyposażenie konstrukcji w oświetlenie LED oraz promienniki. Jeżeli chcesz osłonić siebie, meble i dodatki warto wybrać boczną zabudowę Shutters, Rolety ZIP lub przeszklenia. Zyskasz funkcjonalną przestrzeń do spędzania czasu o dowolnej porze dnia, czy nawet roku.

EN

**The Tarasola Carport** is a modern parking space. It is a solid, fixed roofing that protects your car from the sun, rain, wind and snow. The minimalist form, aesthetically pleasing finish, with no visible fixings and a choice of colours allows the Carport to fit into any environment.

### Tarasola Carport = Tarasola Fix

The carport structure can be successfully used as a standard terrace roofing. In this option, we recommend adding a lower roof in the form of an aesthetically pleasing fabric and equipping the structure with LED lighting and infrared heaters. If you want to cover yourself, your furniture and accessories, it is worth choosing side Shutters, ZIP blinds or glazing. You will gain a functional space to spend time at any time of the day or even year.

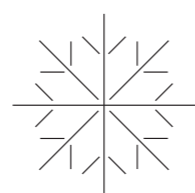
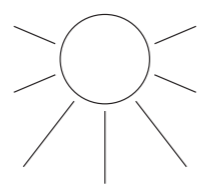
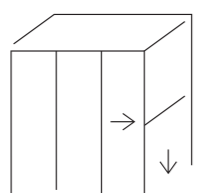

## Carport z panelami fotowoltaicznymi

### Carport with photovoltaic panels

Stale zadaszenie daje możliwość montażu paneli fotowoltaicznych i wykorzystania powstałego prądu, do zasilania sprzętów w gospodarstwie domowym lub do ładowania samochodu elektrycznego.

The fixed roof will provide the opportunity for the installation of photovoltaic panels and the use of the resulting electricity to power household appliances or to charge an electric car.



#### Dach z panelami fotowoltaicznymi

Roof with photovoltaic panels



#### Dach bez paneli fotowoltaicznych

Roof without photovoltaic panels

## Dach dolny - tkanina (opcja)

### Bottom roof - fabric (option)

Opcjonalnie można zamówić dach dolny, który przykryje widoczną od dołu blachę. Wówczas spód dachu jest wykonany z estetycznej tkaniny z belkami, w których można zamontować oświetlenie LED Strip.

As an additional option, a bottom roof can be ordered to cover the exposed roof sheet visible from below. The underside of the roof is then made of an aesthetically elegant fabric with beams in which LED Strip lights can be fitted.



#### Dach dolny z tkaniną

Bottom roof with the fabric



#### Dach dolny bez tkaniny

Bottom roof without the fabric



# Galeria zdjęć

Photo  
gallery

## Tarasola Carport

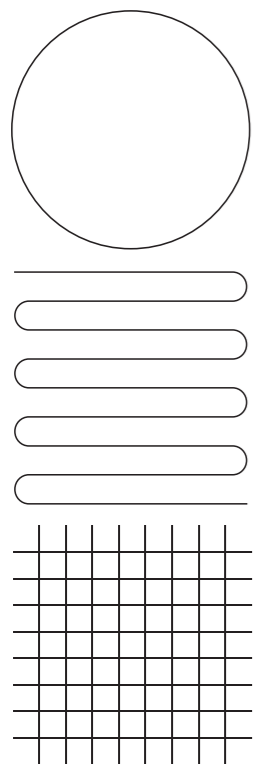



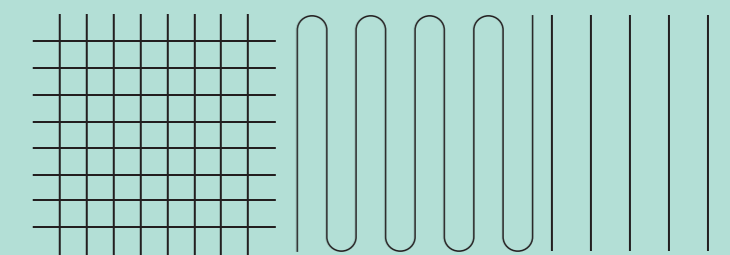











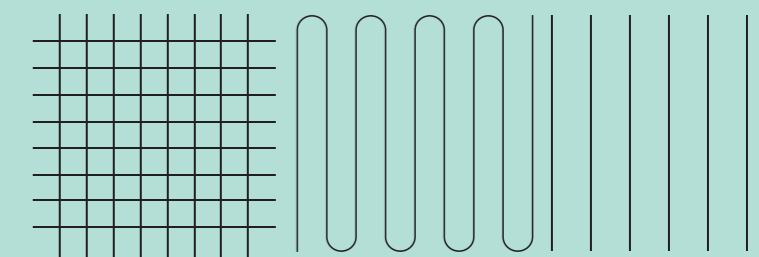





## Tarasola Fix



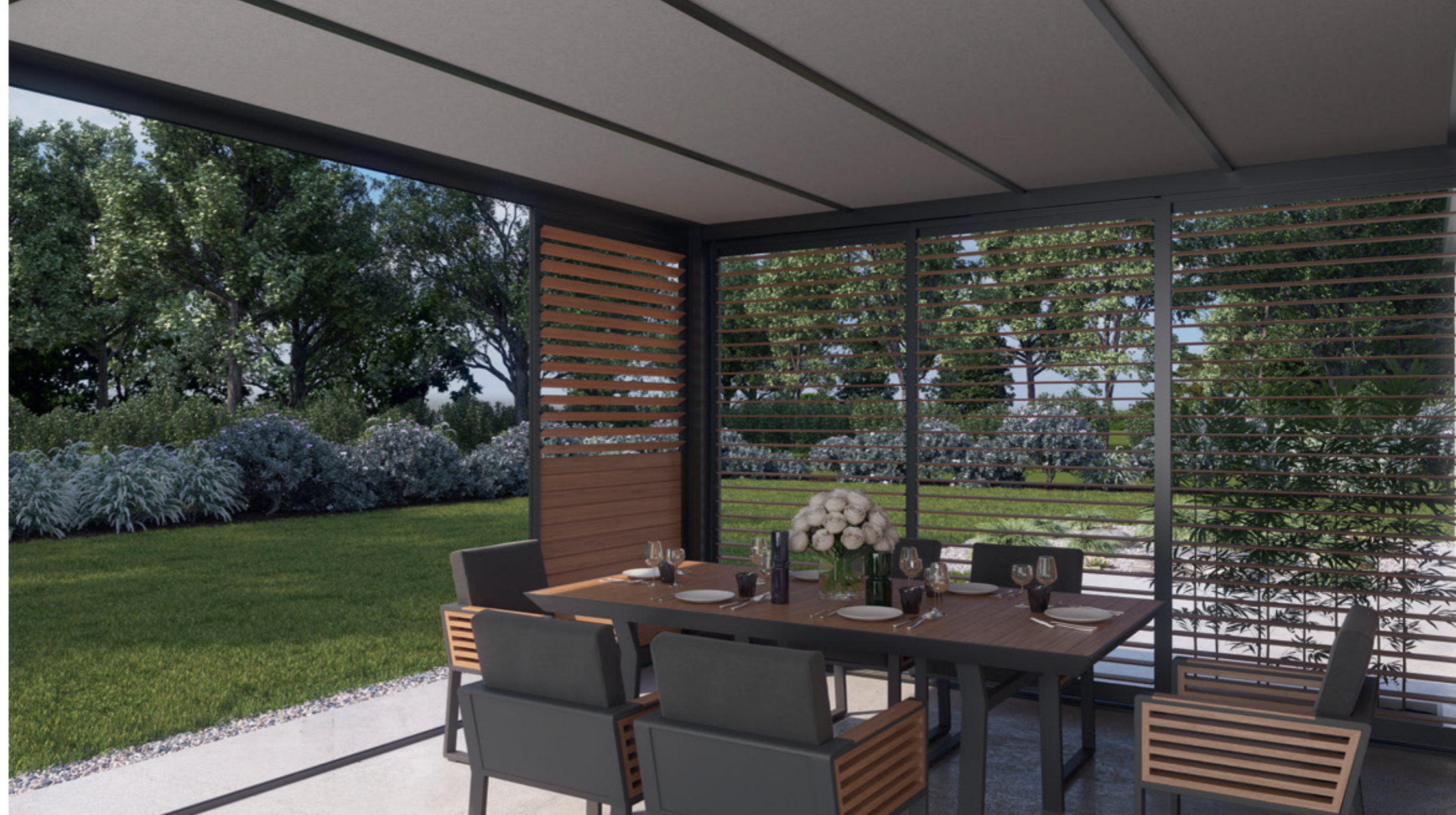
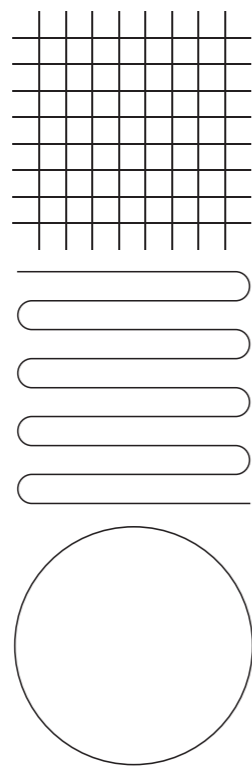







# Cechy kluczowe | Key features



PL

Konstrukcja z **aluminium**, dach z **blachy trapezowej**

System **odprowadzenie wody** w standardzie

Możliwość montażu **paneli fotowoltaicznych** na dachu

Możliwość łączenia **modułowego**

Odporność na wiatr **do 120 km/h**

Odporność na obciążenie śniegiem **72-300 kg/m<sup>2</sup>**

Możliwość montażu tkaniny **jako dach dolny**

EN

**Aluminum** construction, **trapezoidal sheet metal** roof

Integrated, **water drainage system**

Possibility of mounting **photovoltaic panels** to the roof

Option of **modular** connection

Maximum wind resistance **120 km/h**

Resistance to snow load **72-300 kg/m<sup>2</sup>**

Possibility of mounting **fabric on the bottom roof**

# Przekroje | Cross-sections

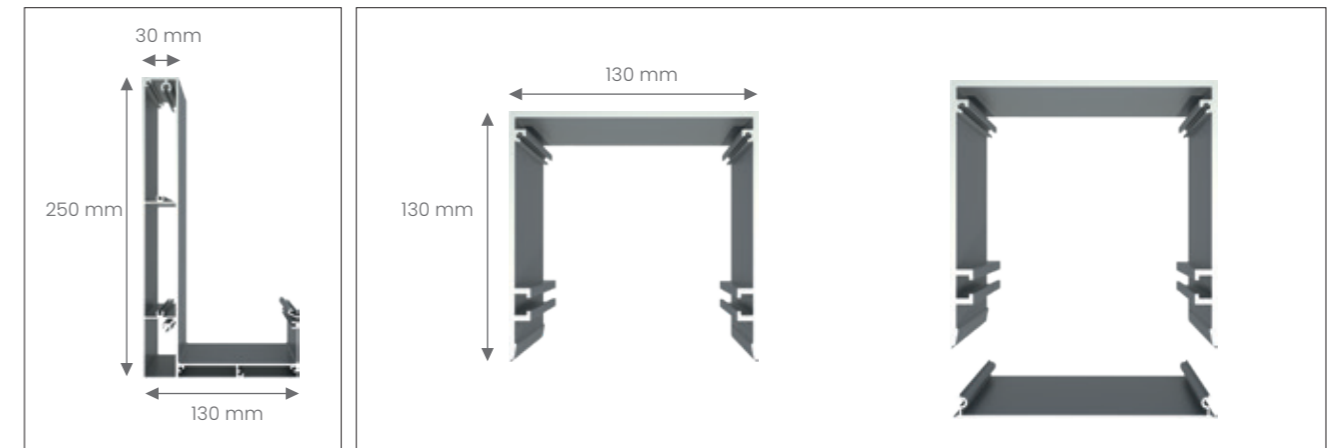

**Profil konstrukcyjny**  
Construction profile

**Otwierany profil podporowy**  
Openable supporting profile

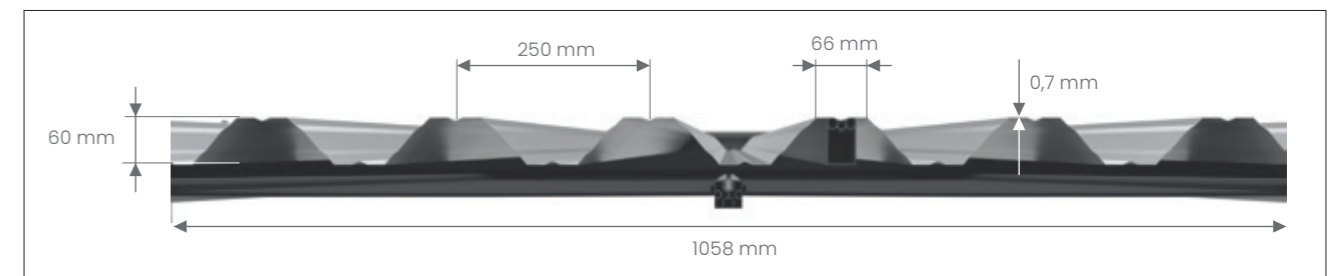

**Przekrój blachy trapezowej T60P** | Cross-section through trapezoidal sheet T60P (mm)

# System odprowadzenia wody Water drainage system

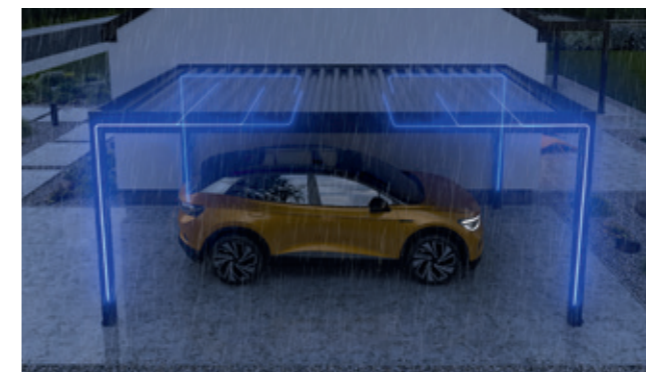



# Modele i maksymalne wymiary

## Models and maximum dimensions

### Carport jednostanowiskowy | One-station Carport

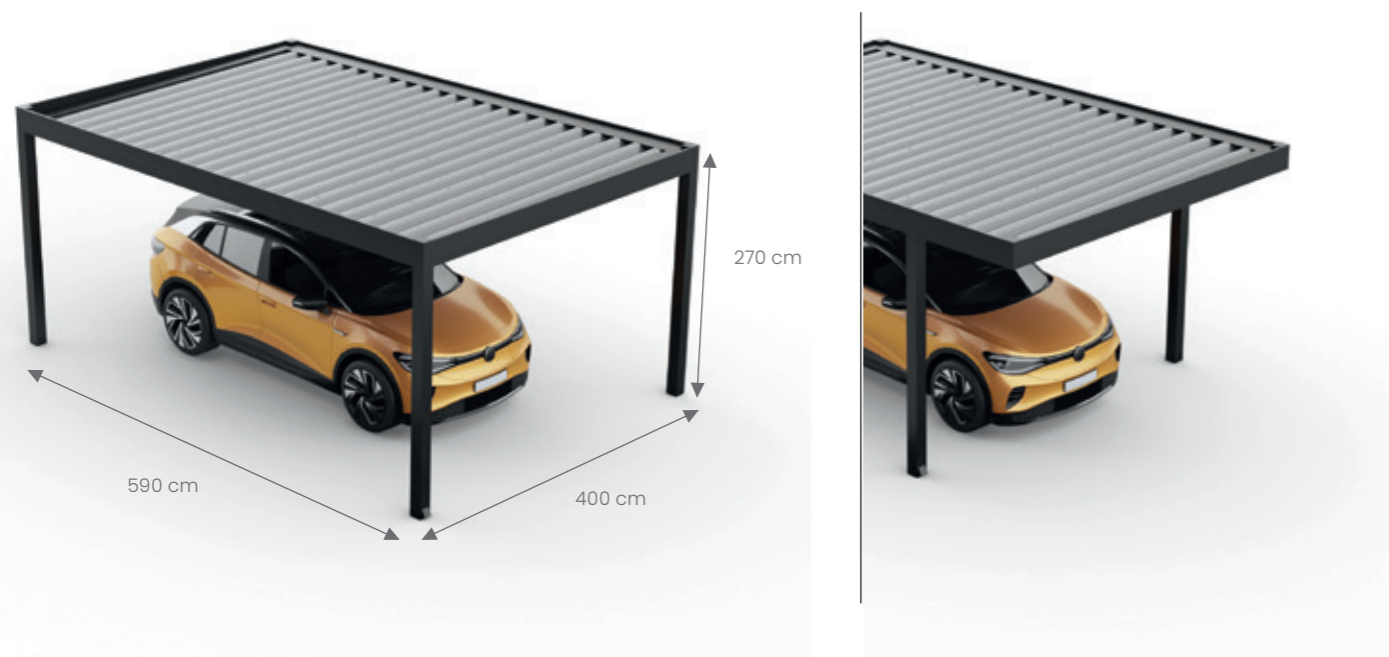

PAVILON	GARDENA	TENDE
Z bramką   With gate	Z bramką   With gate	

### Carport dwustanowiskowy | Two-stations Carport

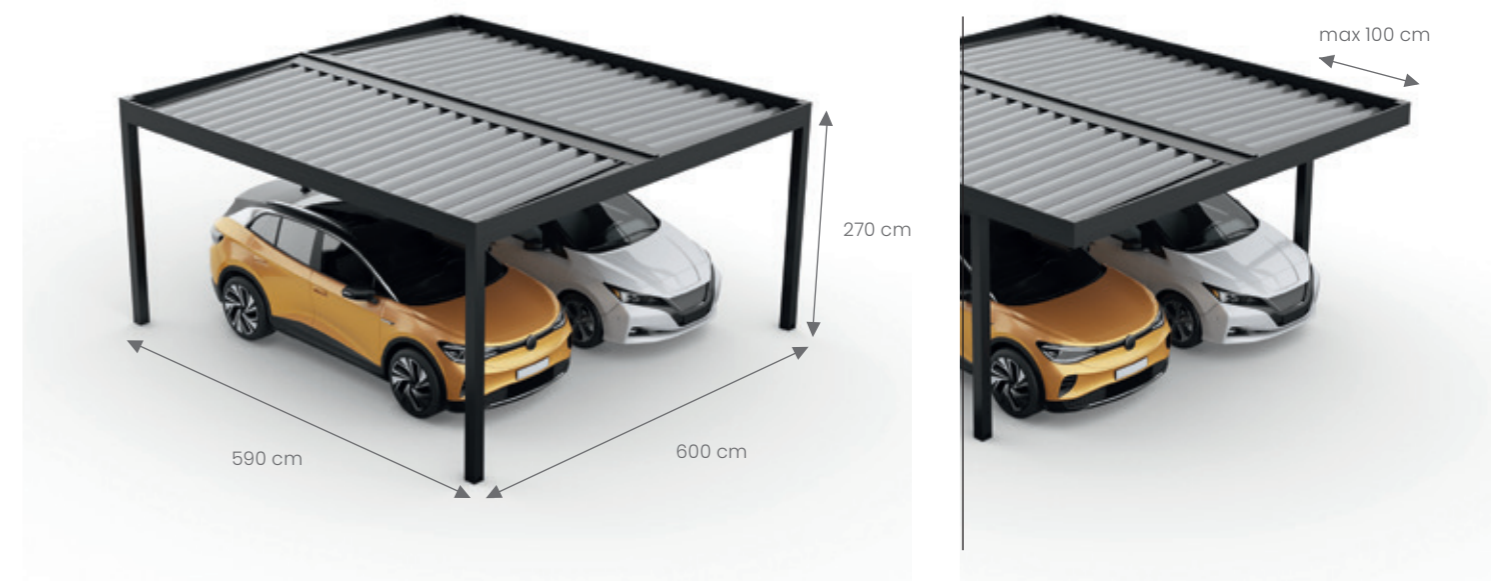

PAVILON	GARDENA	TENDE
Z bramką   With gate	Z bramką   With gate	



**Carport jednostanowiskowy modułowy**  
| One-station Modular Carport

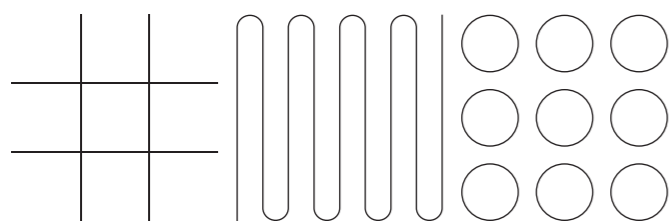
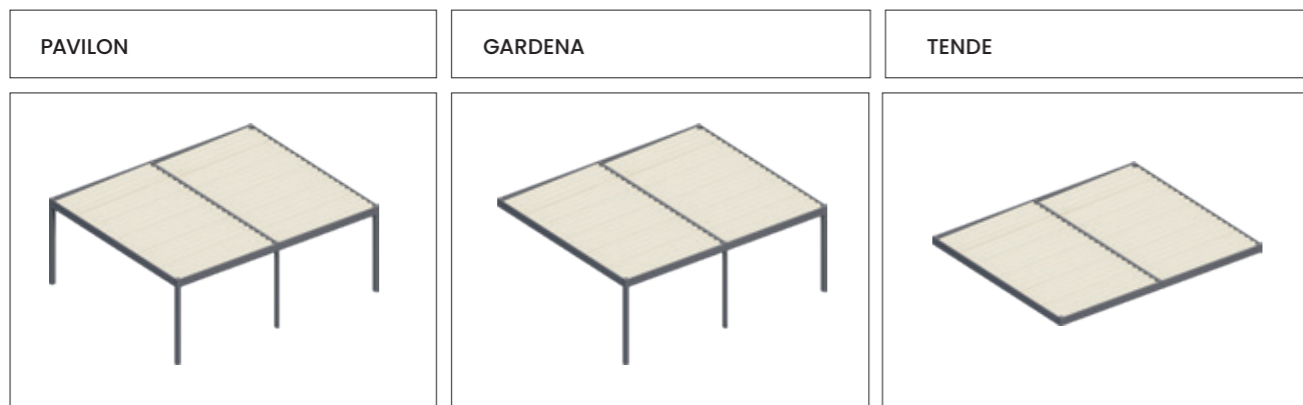

# Ładowarka do samochodu JUICEBOX PRO

## Car Charging Station JUICEBOX PRO



PL

**JuiceBox Pro** Dostępna w poziomie mocy 22 kW, 32A, 3-fazowa. Posiada funkcję Demand Limitation Pro, umożliwiającą ładowanie z maksymalną dostępną mocą bez jej przekraczania.

EN

**JuiceBox Pro** Available in 22 kW, 32A, and 3-phase power level. It has a Demand Limitation Pro feature that allows charging at the maximum available power without exceeding it.



# Panele fotowoltaiczne

## Photovoltaic panels



PL

Tarasola Carport to zadanie tworzone na wymiar. Panele fotowoltaiczne, które mają swoje stałe wymiary wyznaczają pewne ramy, ale znajdujący się pod nimi dach z blachy trapezowej może być dostosowywany wymiarami do potrzeb inwestora.

EN

Tarasola Carport is a tailor-made roof. The photovoltaic panels, which have their own fixed dimensions, define a specific framework, but the trapezoidal sheet metal roof underneath makes it possible to adapt the size of the Carport to the investor's needs. Depending on the chosen dimensions of the structure, the appropriate panel packages are selected.

Przykładowe pakiety | Set of examples

### PAKIET 1 | PACKAGE 1

Carport jednostanowiskowy | One-station Carport

Szerokość   Width	400 cm
Wysięg   Projection	590 cm
Panele   Panels	10 szt.   pcs. TIGER NEO (TYP N 54HL4-B 400-420 W)
Łączna moc   Total output	4200 W

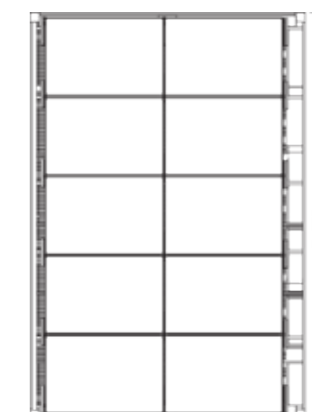

### PAKIET 2 | PACKAGE 2

Carport dwustanowiskowy | Two-stations Carport

Szerokość   Width	530-600 cm
Wysięg   Projection	540-590 cm
Panele   Panels	12 pcs. TIGER NEO (TYP N 54HL4-B 400-420 W)
Łączna moc   Total output	5040 W

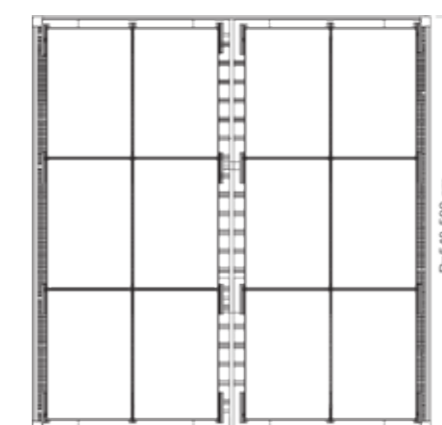



# Zabudowa boczna

## Side development

Rolety ZIP

ZIP Screen

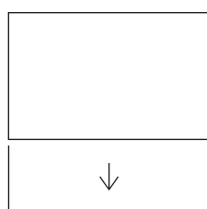

Przeszklenia

Glazing system

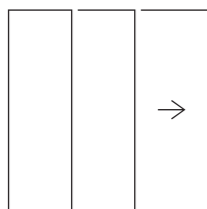

Shutters

Shutters

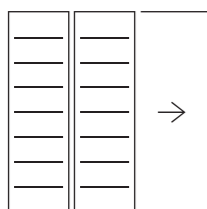

# Akcesoria

## Accessories

Oświetlenie LED

LED Lighting

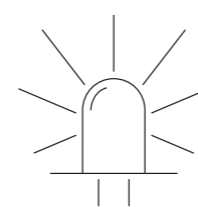

Dach dolny z tkaniną | Bottom roof with the fabric

LED Spot



LED Strip



Dach dolny bez tkaniny | Bottom roof without the fabric

LED Strip



Promiennik ciepła

Infrared heater

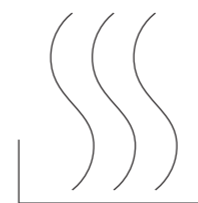



# Paleta Kolorów | Colour Range

## Konstrukcja | Construction

### STANDARD



9010 ST  
kremowo-biały  
creamwhite



9007 ST  
szary  
grey



7016 ST  
antracyt  
anthracite

### DODATKOWE | ADDITIONAL



Dowolny RAL  
Any RAL



Lakier  
drewnopodobny  
Wood-like varnish

## Dach z blachy trapezowej | Trapezoidal sheet metal roof

### STANDARD



9010 ST  
kolor kremowo-biały  
colour creamwhite



9007 ST  
szary  
grey

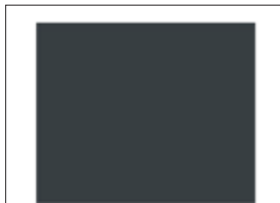

7016 ST  
antracyt  
anthracite



8004 ST  
brązowy  
brown

### DODATKOWE | ADDITIONAL



Dowolny RAL  
Any RAL



Lakier  
drewnopodobny  
Wood-like varnish

## Tkanina Opatex – dach dolny | Opatex Fabric – bottom roof

	biały/biały white/white		antracyt/kremowy anthracite/cream
	szary/jasny szary grey/ light grey		szarobrzązowy/kremowy taupe/cream
	kremowy/kremowy cream/cream		zielony/kremowy green/cream
	szary/kremowy grey/cream		antracyt/antracyt anthracite/anthracite
	bordowy/kremowy bordeaux/cream		czarny/czarny black/black

### DODATKOWE | ADDITIONAL

Veozip | Serge 600 / Copaco | Soltis W 96 | Serge 600 SOLAR

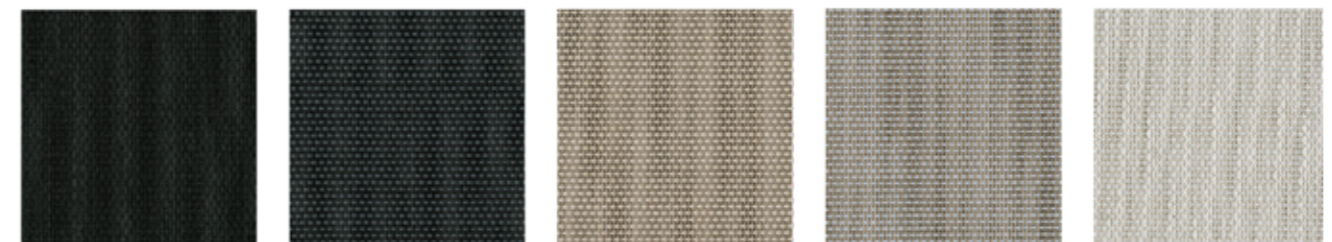





# Certyfikaty | Certificates

Zasłony zewnętrzne. Wymagania eksploatacyjne łącznie z bezpieczeństwem	External blinds. Performance requirements including safety	PN-EN 13561 + A1/2010
Rozporządzenie w sprawie wyrobów budowlanych	Regulation of the construction products	CPR 305/2011
Oświetlenie LED	LED lighting	EN 62031 :2008
Lakierowanie proszkowe	Powder-coating	QUALICOAT
Maksymalne obciążenie wiatrem (przy maksymalnych wymiarach zadaszenia)	Maximum wind resistance (with maximum dimensions)	120 km/h
Obciążenie śniegiem	Snow resistance	72-300 kg/m2

# Nagrody | Awards

 <p>2011-2021 KONSUMENTKI LIDER DEKADY</p> <hr/> <p>Consumer Leader of the Decade</p>	 <p>2020 INNOWATORY WPROST INNOWACJA W KATEGORII DESIGN</p> <hr/> <p>Innovation in the DESIGN category</p>	 <p>2020 GAZELE BIZNESU</p> <hr/> <p>Business Gazelles</p>
--	---	---